

◆ PRECISION INSTRUMENTS FOR TEST AND MEASUREMENT ◆

**MODEL 1419**

**Decade  
Capacitor**

**User and Service Manual**



**IET LABS, INC.**

**Standards • Decades • Strobos • Sound Level Meters • Bridges**

Formerly manufactured by

**GenRad**

534 Main Street, Westbury, NY 11590

TEL: (516) 334-5959 • (800) 899-8438 • FAX: (516) 334-5988

[www.ietlabs.com](http://www.ietlabs.com)

◆ PRECISION INSTRUMENTS FOR TEST AND MEASUREMENT ◆

**MODEL 1419**

**Decade  
Capacitor**

**User and Service Manual**

Copyright © 2009 IET Labs, Inc.

1419 im/March, 2009



**IET LABS, INC.**

**Standards • Decades • Strobes • Sound Level Meters • Bridges**

Formerly manufactured by

**GenRad**

534 Main Street, Westbury, NY 11590

TEL: (516) 334-5959 • (800) 899-8438 • FAX: (516) 334-5988

[www.ietlabs.com](http://www.ietlabs.com)

◆ PRECISION INSTRUMENTS FOR TEST AND MEASUREMENT ◆



---

**IET LABS, INC.**

534 Main Street, Westbury, NY 11590

[www.ietlabs.com](http://www.ietlabs.com)

TEL: (516) 334-5959 • (800) 899-8438 • FAX: (516) 334-5988

## **WARRANTY**

We warrant that this product is free from defects in material and workmanship and, when properly used, will perform in accordance with applicable IET specifications. If within one year after original shipment, it is found not to meet this standard, it will be repaired or, at the option of IET, replaced at no charge when returned to IET. Changes in this product not approved by IET or application of voltages or currents greater than those allowed by the specifications shall void this warranty. IET shall not be liable for any indirect, special, or consequential damages, even if notice has been given to the possibility of such damages.

THIS WARRANTY IS IN LIEU OF ALL OTHER WARRANTIES, EXPRESSED OR IMPLIED, INCLUDING BUT NOT LIMITED TO, ANY IMPLIED WARRANTY OF MERCHANTABILITY OR FITNESS FOR ANY PARTICULAR PURPOSE.



## WARNING



OBSERVE ALL SAFETY RULES  
WHEN WORKING WITH HIGH VOLTAGES OR LINE VOLTAGES.

**Dangerous voltages may be present inside this instrument. Do not open the case  
Refer servicing to qualified personnel**

### **HIGH VOLTAGES MAY BE PRESENT AT THE TERMINALS OF THIS INSTRUMENT**

WHENEVER HAZARDOUS VOLTAGES (> 45 V) ARE USED, TAKE ALL MEASURES TO  
AVOID ACCIDENTAL CONTACT WITH ANY LIVE COMPONENTS.

USE MAXIMUM INSULATION AND MINIMIZE THE USE OF BARE  
CONDUCTORS WHEN USING THIS INSTRUMENT.

**Use extreme caution when working with bare conductors or bus bars.**

WHEN WORKING WITH HIGH VOLTAGES, POST WARNING SIGNS AND  
KEEP UNREQUIRED PERSONNEL SAFELY AWAY.



## CAUTION



DO NOT APPLY ANY VOLTAGES OR CURRENTS TO THE TERMINALS OF THIS  
INSTRUMENT IN EXCESS OF THE MAXIMUM LIMITS INDICATED ON  
THE FRONT PANEL OR THE OPERATING GUIDE LABEL.

# Instructions

## SOLID-DIELECTRIC CAPACITORS

Figure 1.  
The equivalent circuit  
of a solid-dielectric capacitor.

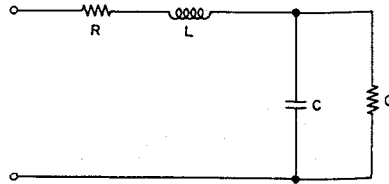

A solid dielectric capacitor can be represented by the equivalent circuit of Figure 1, in which C is the electrostatic capacitance, and G is the parallel conductance. R is the equivalent series resistance, and L is the equivalent series inductance of the complete metallic structure including the leads.

The conductance G includes both the conductance due to dielectric losses and the d-c leakage conductance. The dissipation factor, D, which at low frequencies is determined mainly by G, at high frequencies is also dependent upon the series metallic resistance, R.

The series inductance, L, acts to increase the capacitance as the resonant frequency of the L-C combination is approached. At low frequencies, principally below the audio range, the capacitance increases as a result of dielectric absorption caused by interfacial polarizations in the dielectric. Although these polarizations occur at frequencies of the order of  $10^{-3}$  to  $10^{-6}$  cycles per second, their effects are measurable in the working frequency range of the capacitor. The magnitude of the effect varies with the dielectric material.

Figure 2 shows the fractional change in capacitance as a function of frequency for a 0.001- $\mu$ f mica dielectric capacitor. The dashed line slanting downward to the right is the capacitance characteristic resulting from interfacial polarization; that slanting upward to the right shows the effect of resonance with the effective series inductance, L, which causes the fractional change in capacitance to increase as the square of frequency. The solid curve is the sum of these two effects and is the over-all frequency characteristic.

The solid curve of Figure 3 shows the behavior of dissipation factor as a function of frequency for the same capacitor. Three components contribute to this characteristic: (1) a constant dissipation factor caused by a residual polarization shown by the horizontal dashed line, (2) the loss caused by interfacial polarizations, shown by the dashed line slanting downward to the right, and (3) ohmic loss in the leads and electrodes, which causes the dissipation factor to increase as the  $3/2$  power of the frequency, shown by the dashed line slanting upward to the right. The d-c leakage conductance also contributes to the over-all

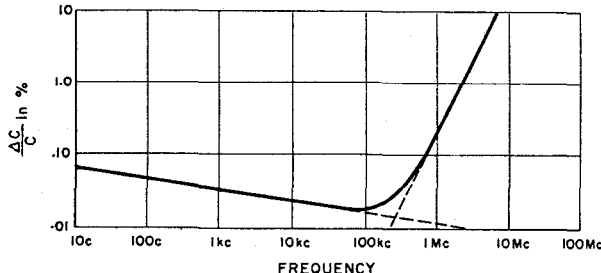

Figure 2. The variation, with frequency, of capacitance of a fixed solid-dielectric capacitor.

dissipation factor, but for good dielectrics its effect is negligible in comparison with the other factors. If shown, it would be a line slanting downward to the right at  $45^\circ$ .

Fractional change in capacitance and absolute value of dissipation factor each has a minimum value, which occurs at a frequency that varies inversely with capacitance and that can be as low as 1 kc and as high as 1 Mc for capacitance values in the range from 1 $\mu$ f to 100 $\mu$ f.

In the following pages are described fixed, solid-dielectric capacitors of various materials assembled in decade combinations. The Type 1419-K Decade Capacitor and the Types 980-F, -G, and -H Decade Capacitor Units use Type 505 Capacitors with silvered mica as the dielectric material. High dielectric strength, low dielectric loss, and high dimensional stability make high-quality mica the best available solid dielectric for alternating-current standard capacitors. Silvered-mica sheets with soft metallic foil interposed between sheets insure intimate and stable contact between electrodes and the dielectric, as well as low series resistance.

For use at dc or extremely low frequencies, mica dielectric is at some disadvantage because of the relatively large increase in capacitance over the audio-frequency value. This increase is caused by interfacial polarizations having extremely long relaxation times.

Polystyrene exhibits the remarkable property of having dielectric constant and dissipation factor very nearly invariant with frequency, the total increase in d-c dielectric constant over the audio-frequency value being only a small fraction of a percent (in contrast, mica may exhibit a rise of the order of 3%). The Type 1419-A Decade Capacitor and the Types 980-A, -B, and -C Decade Capacitor Units use hermetically sealed capacitors, wound and connected non-inductively, from carefully processed polystyrene film.

The Type 980-M and -N Decade Capacitors use molded silvered-mica capacitors, and the Type 980-L has paper dielectric with a viscous impregnant to improve stability. These three decades, assembled into a single cabinet, form the Type 1419-M Decade Capacitor. While not as accurate in calibration, nor as low in dissipation factor as the all-mica and the polystyrene units, these capacitors have many uses in the electronics laboratory.

When capacitors are assembled into decades, as in the Type 980 Decade Capacitor Units, the residual impedances are increased by those of the switch and wiring. The assembling of several decades into a 1419 Decade Capacitor adds more series residuals and more terminal capacitance.

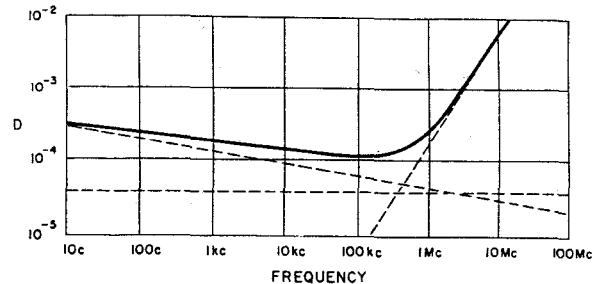

Figure 3. The variation, with frequency, of dissipation factor of a fixed solid-dielectric capacitor.

# DECADE CAPACITORS

Types 1419-A and -B  
Polystyrene Dielectric

Type 1419-K  
Silvered-Mica Dielectric

Type 1419-M  
Silvered-Mica and Paper Dielectric

General Radio Decade Capacitors are assemblies of three Type 980 Decade Capacitors in shielded cabinets. All models have a multiplicity of uses in the electronics laboratory, as circuit elements in resonant circuits, bridges, filters, and experimental equipment. Each individual model has also its own specialized applications, by virtue of its design and construction features. Each model is described below; complete specifications are given.

## TYPES 1419-A AND -B POLYSTYRENE DECADE CAPACITOR

**USES:** Owing to its very low dielectric absorption, the Type 1419-A Polystyrene Decade Capacitor is particularly useful in research and development work on computer and integrator circuits and on low-level amplifiers. Its constancy of capacitance and dissipation factor as a function of frequency also makes it extremely useful in measuring circuits and as a component in filters and tuned circuits. High insulation resistance and low dielectric absorption make it a nearly ideal capacitor for dc work.

**DESCRIPTION:** This decade capacitor is based on development work and manufacturing experience at General Radio since 1940. The individual capacitor units for Types 980-A, -B, -C, and -D are designed to be essentially non-inductive and are heat-stabilized, so that their long-time stability approaches that of the best silvered-mica capacitors.

The capacitors are wound in spool form from continuous interleaved tapes of polystyrene and metal foil. The foils projecting at each end of the roll are soldered together to minimize inductance and series resistance.

The tape used for the dielectric is specially prepared of purified high-molecular-weight polystyrene, having very high resistance and freedom from polarization. Hermetic sealing with Teflon feed-through insulators assures high performance even under adverse humidity conditions.

Terminals are provided for both 2-terminal and 3-terminal connections.

**FEATURES:** High insulation resistance.  
Low dielectric absorption.

Low dielectric loss.  
Capacitance and dissipation factor vary only slightly with frequency from dc through the audio frequency range.  
Completely shielded and hermetically sealed.  
All insulation of highest available quality.  
Three-terminal construction.

## TYPE 1419-K DECADE CAPACITOR

**USES:** This high-quality decade capacitor finds uses in every laboratory; in tuned circuits, impedance bridges, filters, or in any circuit where an accurate and stable step-adjustable capacitor is necessary.

Mica dielectric is used throughout, which permits operation at higher temperatures than do polystyrene types.

**DESCRIPTION:** The Type 1419-K Decade Capacitor is an assembly of Type 980-F, -G, and -H Decade Capacitor Units mounted in a shielded cabinet. The individual capacitors are General Radio Type 505 units, which are assembled from selected sheets of silvered mica.

**FEATURES:** High stability. 3-Terminal construction.  
0.5% accuracy. Low dissipation factor.  
Low temperature coefficient. Shielding case.

## TYPE 1419-M DECADE CAPACITOR

**USES:** The Type 1419-M Decade Capacitor is a general purpose capacitor adjustable in 0.001- $\mu$ f steps up to 1.110  $\mu$ f. In experimental circuits where dissipation factor is not critical it offers excellent performance at moderate cost. It is designed for both two- and three-terminal use.

**DESCRIPTION:** The capacitor decades used in this box are Types 980-L, -M, and -N. The Types 980-M and 980-N use molded, characteristic-C, silvered-mica capacitors. The highest capacitance decade, Type 980-L, uses stabilized paper-dielectric units. These are impregnated with a viscous compound which stays in place despite shock and temperature extremes, thus enhancing capacitance stability. They are enclosed in sealed tubular containers for moisture protection before being mounted in the wax-sealed drawn-aluminum container attached to the switch frame.

## TYPE 980 DECADE CAPACITOR

**USES:** The Type 980 Decade Capacitor Units are the individual decades used in the Type 1419 Decade Capacitors. They can be built into tuned circuits, wave filters, oscillators, analyzers, amplifiers, equalizers, and other permanent or experimental equipment.

Decades are available in three different dielectric materials: polystyrene, 2 grades of mica, and paper. The advantages of each type for particular uses are discussed in the descriptions of the Type 1419 Decade Capacitors.

**DESCRIPTION:** Each decade consists of four capacitors of magnitudes in the ratio of 1, 2, 2, 5. The switch selects

parallel combinations to give all integral values between 1 and 10.

The switch, which is designed for low capacitance and low losses, is rigidly constructed and includes a detent mechanism for positive location of position. The switch dielectric, including the shaft, is heat-resistant, cross-linked polystyrene. Contacts are made by cams riding on phosphor-bronze springs.

Units are furnished complete with knob, photo etched dial plate, and switch stops. The switch, with dial plate and knobs, is available separately.

# SPECIFICATIONS

TYPE NUMBER	1419-A			1419-B		1419-K			1419-M		
	A	B	C	D		F	G	H	L	M	N
Type 980 Decades Used	A			B		C			D		
Capacitance per Step ( $\mu\text{f}$ )	0.1	.01	.001	.0001		0.1	.01	.001	0.1	.01	.001
Dielectric	Polystyrene					Mica			Paper	Mica	Mica
Maximum Capacitance of Box ( $\mu\text{f}$ )	1.110			1.1110		1.110			1.110		
Zero Capacitance (pf)	2-terminal			37		50			41		
	3-terminal			15		20			13		
Ac. Accuracy	2-terminal			$\pm 1\%$	$\pm 1\%$	$\pm 1\%$	$\pm (1\% + 2 \text{ pf})$		$\pm 0.5\%$	$\pm 0.5\%$	$\pm 0.5\%$
	3-terminal			$\pm 1\%$	$\pm 1\%$	$\pm 1.5\%$	$\pm 1\%$ to $-(2\% + 4 \text{ pf})$		$\pm 0.5\%$	$\pm 0.5\%$	$\pm 1\%$
Dissipation Factor at 1 kc	<.0002					<.0003			<.005	<.001	<.001
Insulation Resistance in ohms at 100 v, 23 C, 50% RH	> $10^{12}$					> $3.5 \times 10^9$			> $10^9$		
Temperature Coefficient of Capacitance (ppm/ $^{\circ}\text{C}$ )	-140, nominal					+35 $\pm$ 10			+180 nominal	EIA Characteristic C	
Maximum Operating Temperature (C)	65					90			90		
Maximum Operating Voltage (DC or peak)	500					500			500	500	500
Frequency Limit for Maximum Voltage <sup>3</sup>	10 kc	100 kc	1 Mc	10 Mc	10 kc	100 kc	1 Mc	10 Mc	2 kc	100 kc	1 Mc
Frequency Characteristic	See Figure 4										
Dc Cap / 1-kc Cap	<1.001					Typically 1.03					
Dielectric Absorption						See Voltage Recovery					
Voltage Recovery <sup>2</sup>	<0.1%					<3%					
Terminals	Three Type 938 Binding Posts with grounding link					Three Type 938 Binding Posts with grounding link			Three Type 938 Binding Posts with grounding link		
Mounting	Aluminum Panel and Cabinet					Aluminum Panel and Cabinet			Aluminum Panel and Cabinet		
Over-all Dimensions	13 by 4 $\frac{1}{8}$ by 5 inches (330 by 110 by 130 mm)					14-1/8 by 5-1/2 by 6 inches (359 by 140 by 155 mm)			14-1/8 by 4-5/16 by 5-1/2 inches (359 by 110 by 140 mm)		
	16 $\frac{1}{8}$ by 4 $\frac{1}{8}$ by 5 inches (415 by 110 by 130 mm)										
Net Weight	8 $\frac{3}{8}$ lb (3.8 kg)					11 $\frac{1}{4}$ lb (5.1 kg)			6 $\frac{1}{4}$ lb (2.9 kg)		
				10 $\frac{1}{2}$ lb (4.8 kg)							

<sup>1</sup>Capacitance increments from zero position are within this percentage of the indicated value for any setting.  
<sup>2</sup>Final % of original charging voltage after a charging period of one hour and a 10-second discharge through a resistance equal to one ohm per volt of charging.  
<sup>3</sup>At frequencies above the indicated maximum, the allowable voltage decreases and is (approximately) inversely proportional to frequency. These limits correspond to a temperature of 40 C for a power dissipation of 2.5 watts for TYPE 980-F, one watt for TYPES 980-G, -H and -J, and 3.5 watts for all other units.

Figure 4. (Left) Typical plot of change in capacitance at maximum setting of each decade as a function of frequency. The capacitance curves are referred to the value the capacitor would have if there were no interfacial polarization and no series in-

ductance. Since the capacitors are adjusted to their rated accuracy at 1 kc, the 1-kc value on the plots should be used as a basis of reference in estimating the frequency error. (Right) Typical plot of dissipation factor as a function of frequency.

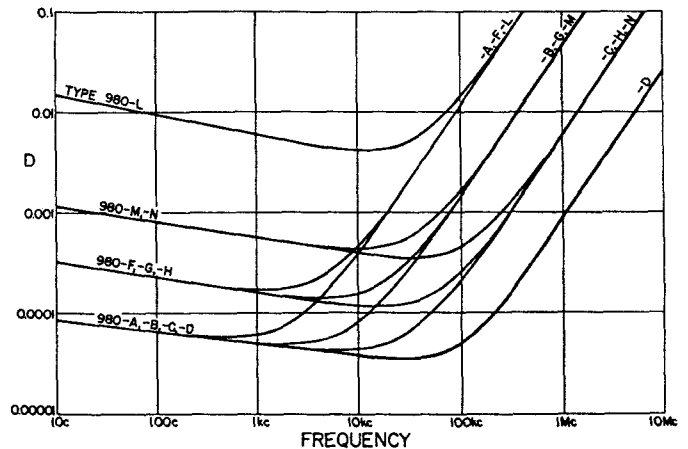
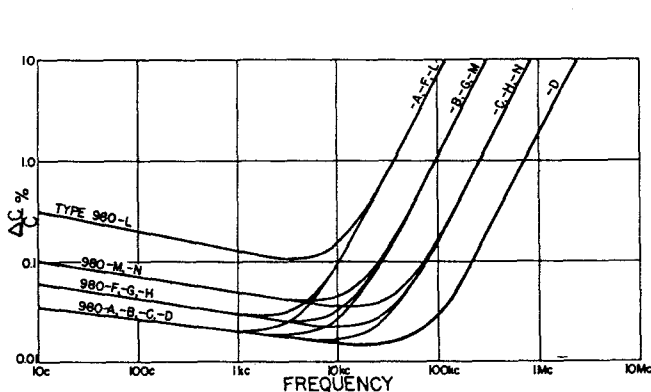



**MECHANICAL PARTS LIST**

Qty	Description	GR Part No.	Fed Mfg Code	Mfg Part No.	Fed Stock No.
2	Binding post insul.	0938-3000	24655	0938-3000	
2	Bushing	0938-7130	24655	0938-7130	
1	Shorting Link	5080-4800	24655	5080-4800	5940-927-7452
1	Binding post, uninsul.	0938-3022	24655	0938-3022	
1	Spacer	7720-2500	24655	7720-2500	
4	Knob asm., inc.	5500-5421	24655	5500-5421	
	Knob	5500-5401	24655	5500-5401	
	Retainer	5220-5401	24655	5220-5401	
1	Cabinet asm.	1432-1120	24655	1432-1120	
4	Foot	5260-1200	70485	#18, 3/4"	6625-918-9449

**1419-A**

**ELECTRICAL PARTS LIST**

Ref Des	Description	GR Part No.	Fed Mfg Code	Mfg Part No.
SWITCH ASS'Y (0.1 μF/Step) includes:				
CAPACITORS				
C1	Poly, 0.1 μF ±0.4% 500 V	4872-1170	24655	4872-1170
C2 and				
C3	Poly, 0.2 μF ±0.4% 500 V	4872-1180	24655	4872-1180
C4	Poly, 0.25 μF ±0.4% 500 V	4872-1183	24655	4872-1183
SWITCH ASS'Y (0.01 μF/Step) includes:				
CAPACITORS				
C1	Poly, .01 μF ±0.5% 500 V	4872-1100	24655	4872-1100

**ELECTRICAL PARTS LIST (cont)**

Ref Des	Description	GR Part No.	Fed Mfg Code	Mfg Part No.
C2	Poly, .02 μF ±0.5% 500 V	4872-1110	24655	4872-1110
C3	Poly, .05 μF ±0.5% 500 V	4872-1111	24655	4872-1111
C4	Poly, .02 μF ±0.5% 500 V	4872-1110	24655	4872-1110
SWITCH ASS'Y (0.001 μF/Step) includes:				
CAPACITORS				
C1	Poly, 1000 pF ±0.5% 500 V	4872-1123	24655	4872-1123
C2	Poly, 2000 pF ±0.5% 500 V	4872-1101	24655	4872-1101
C3	Poly, 5000 pF ±0.5% 500 V	4872-1102	24655	4872-1102

**1419-B**

**ELECTRICAL PARTS LIST**

Ref Des	Description	GR Part No.	Fed Mfg Code	Mfg Part No.
SWITCH ASS'Y (0.1 μF/Step) includes:				
CAPACITORS				
C1	Poly, 0.1 μF ±0.4% 500 V	4872-1170	24655	4872-1170
C2 and				
C3	Poly, 0.2 μF ±0.4% 500 V	4872-1180	24655	4872-1180
C4	Poly, 0.25 μF ±0.4% 500 V	4872-1183	24655	4872-1183
SWITCH ASS'Y (0.01 μF/Step) includes:				
CAPACITORS				
C1	Poly, .01 μF ±0.5% 500 V	4872-1100	24655	4872-1100
C2	Poly, .02 μF ±0.5% 500 V	4872-1110	24655	4872-1110
C3	Poly, .05 μF ±0.5% 500 V	4872-1111	24655	4872-1111
C4	Poly, .02 μF ±0.5% 500 V	4872-1110	24655	4872-1110

**ELECTRICAL PARTS LIST (cont)**

Ref Des	Description	GR Part No.	Fed Mfg Code	Mfg Part No.
SWITCH ASS'Y (0.001 μF/Step) includes:				
CAPACITORS				
C1	Poly, .1000 pF ±0.5% 500 V	4872-1123	24655	4872-1123
C2	Poly, 2000 pF ±0.5% 500 V	4872-1101	24655	4872-1101
C3	Poly, .5000 pF ±0.5% 500 V	4872-1102	24655	4872-1102
C4	Poly, 2000 pF ±0.5% 500 V	4872-1101	24655	4872-1101
SWITCH ASS'Y (100 pF/Step) includes:				
CAPACITORS				
C1	Poly, 99.4 pF ±0.6% 500 V	4872-1120	24655	4872-1120
C2	Poly, 199.5 pF ±0.6% 500 V	4872-1121	24655	4872-1120
C3	Poly, .499 pF ±0.6% 500 V	4872-1122	24655	4872-1122
C4	Poly, 199.5 pF ±0.6% 500 V	4872-1121	24655	4872-1120

**1419-K**

**ELECTRICAL PARTS LIST**

Ref Des	Description	GR Part No.	Fed Mfg Code	Mfg Part No.
SWITCH ASS'Y (0.1 μF/Step) includes:				
CAPACITORS				
C1	0.1 μF	0505-4720	24655	0505-4720
C2 and				
C3	0.2 μF	0505-4721	24655	0505-4721
C4	0.5 μF	0505-4724	24655	0505-4724
SWITCH ASS'Y (0.01 μF/Step) includes:				
CAPACITORS				
C1	9996 pF	0505-4910	24655	0505-4910

**ELECTRICAL PARTS LIST (cont)**

Ref Des	Description	GR Part No.	Fed Mfg Code	Mfg Part No.
C2 and				
C3	0.02 μF	0505-4613	24655	0505-4613
C4	0.05 μF	0505-4618	24655	0505-4618
SWITCH ASS'Y (0.001 μF/Step) includes:				
CAPACITORS				
C1	996 pF	0505-4880	24655	0505-4880
C2 and				
C3	1996 pF	0505-4890	24655	0505-4890
C4	4997 pF	0505-4900	24655	0505-4900

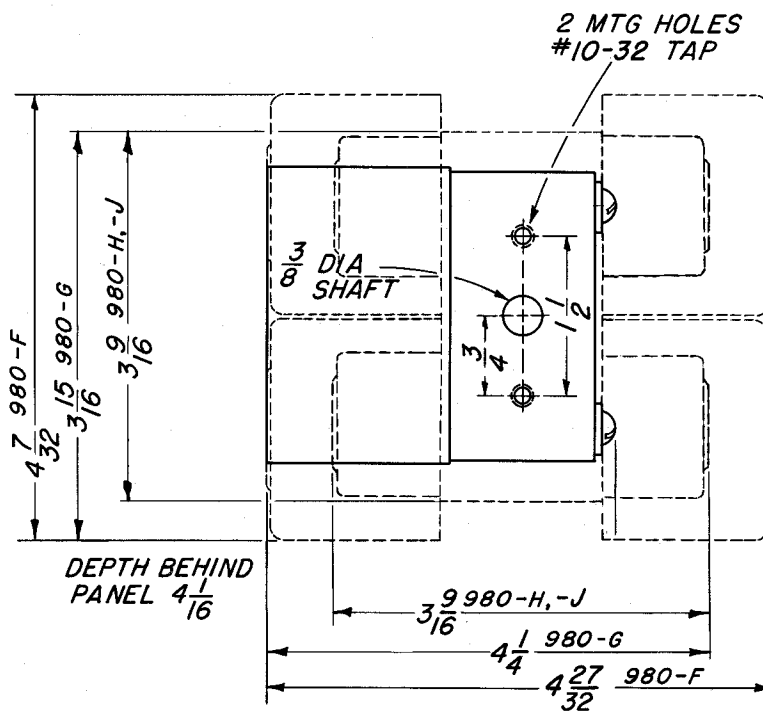
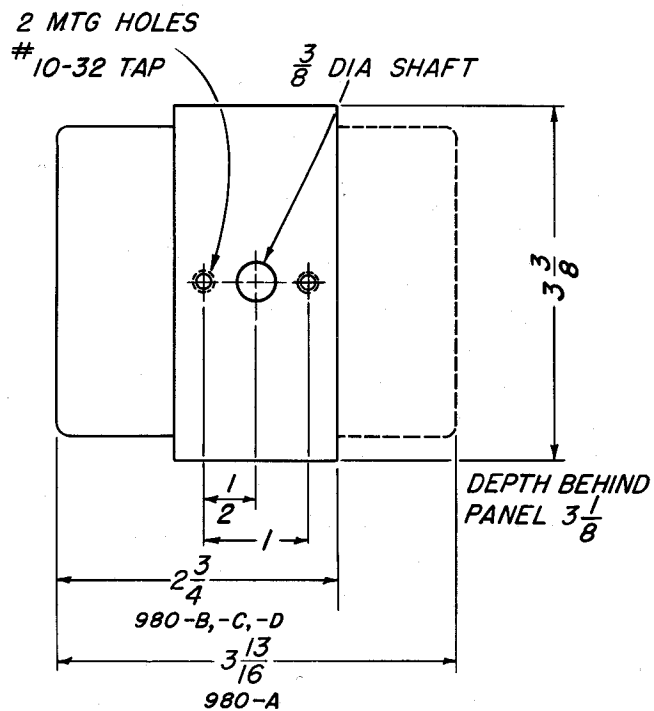

Dimensions for the Type 980  
Decade Capacitors.

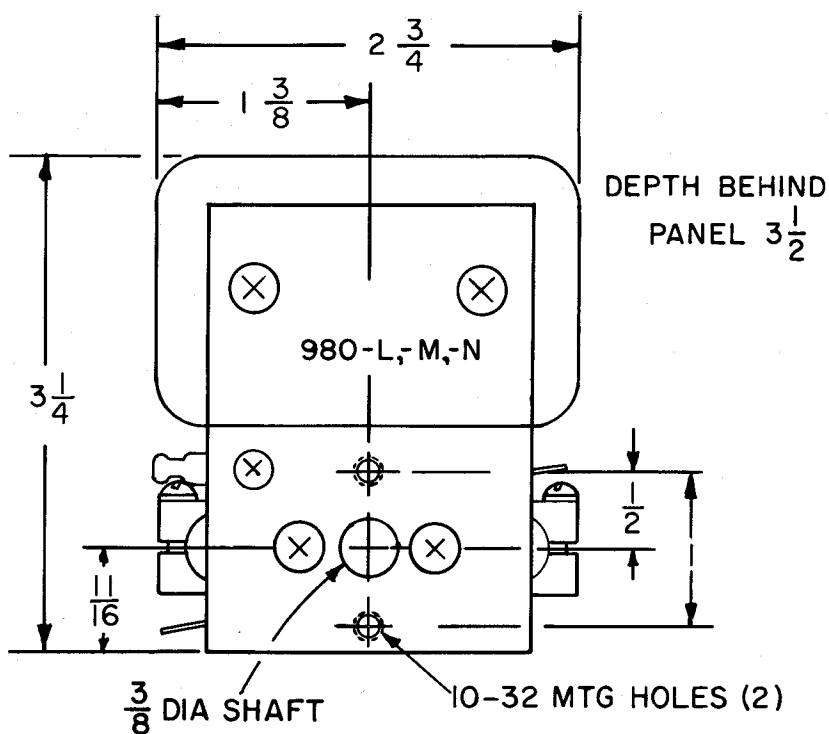
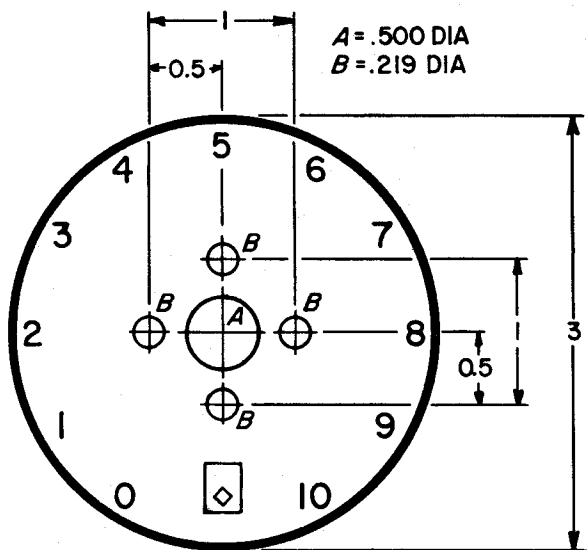



**IET LABS, INC.**

**Standards • Decades • Strokes • Sound Level Meters • Bridges**

Formerly manufactured by

**GenRad**

534 Main Street, Westbury, NY 11590

TEL: (516) 334-5959 • (800) 899-8438 • FAX: (516) 334-5988

[www.ietlabs.com](http://www.ietlabs.com)



**IET LABS, INC.**

**Standards • Decades • Strobes • Sound Level Meters • Bridges**

Formerly manufactured by

**GenRad**

534 Main Street, Westbury, NY 11590

TEL: (516) 334-5959 • (800) 899-8438 • FAX: (516) 334-5988

[www.ietlabs.com](http://www.ietlabs.com)